

Test 2: Are there time Correlations?

((economists knew these results, qualitatively, as volatility clustering...so calculate autocorrelation function and get a “law”))

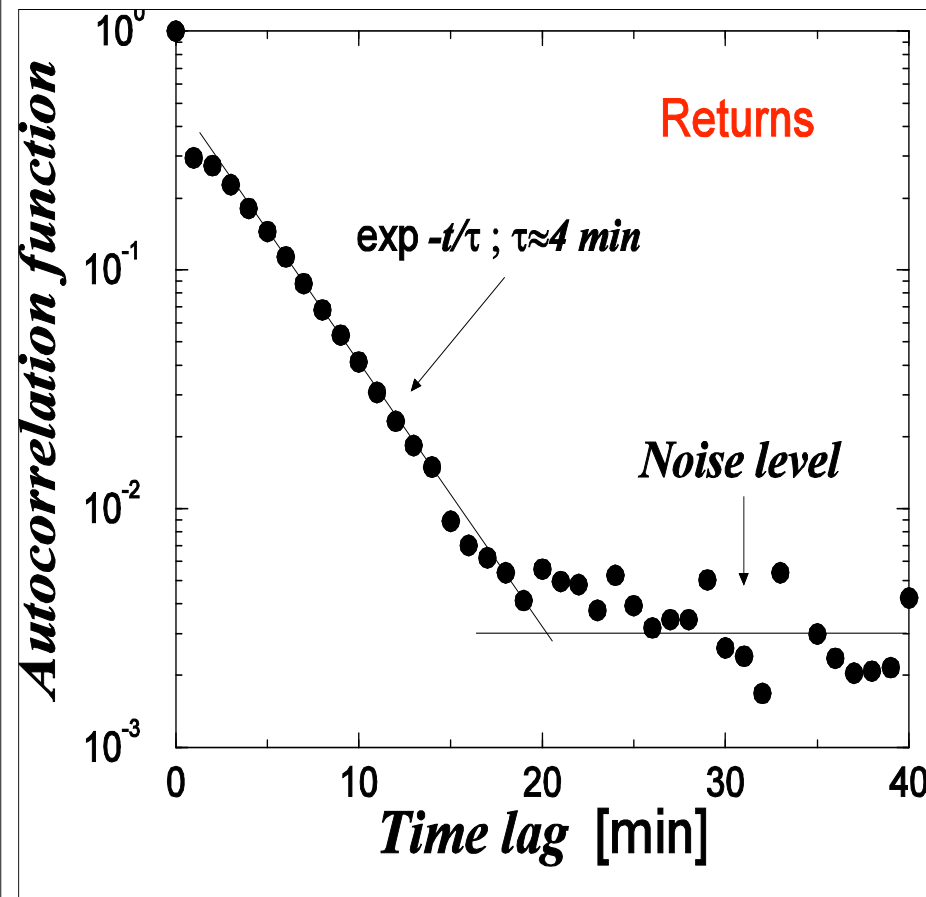

- Returns are UN-correlated after 4 min
- Absolute value of returns (volatility) is long range correlated, so returns **CAN NOT BE** serially independent.

$$\leftarrow R_t = \text{sgn}(R_t) \quad |R_t|$$

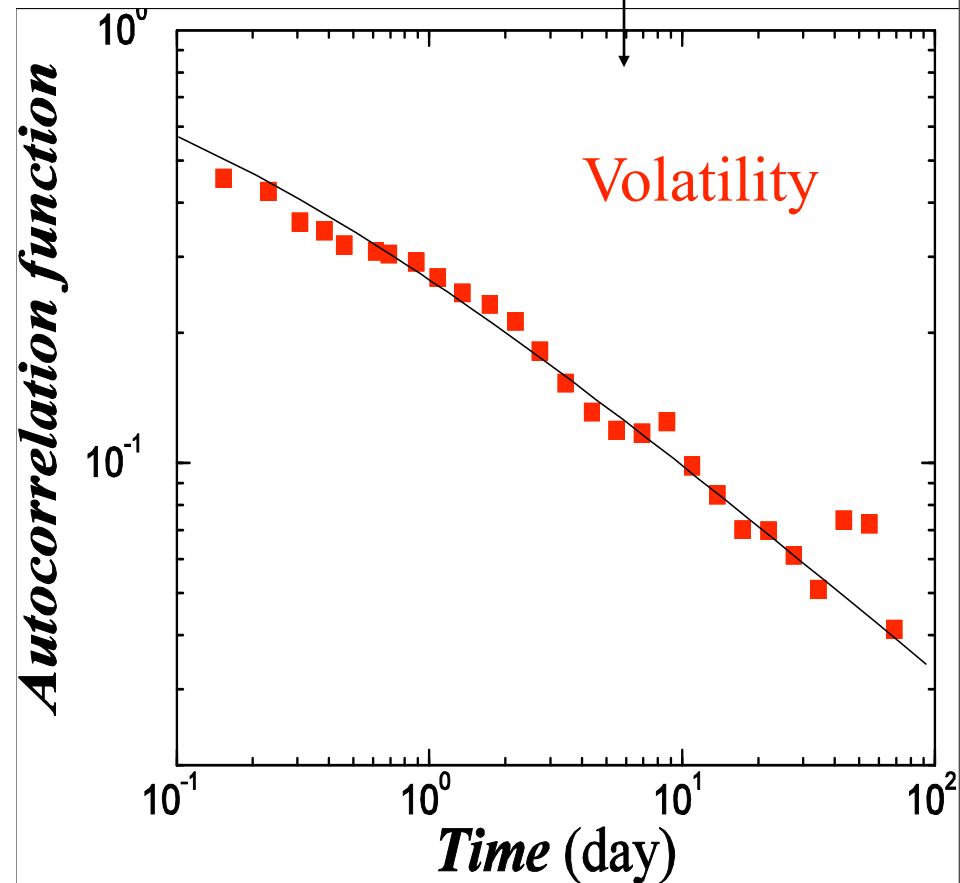

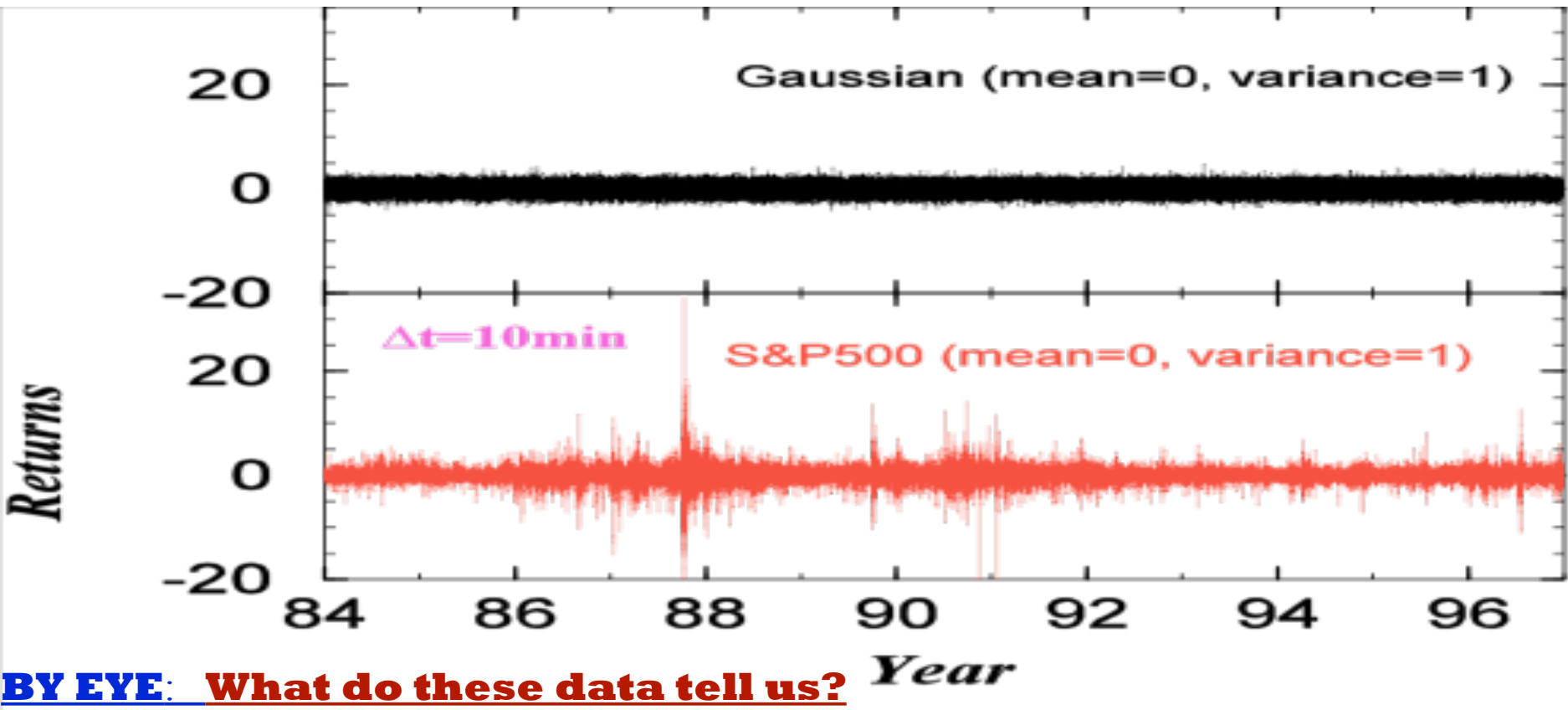

Q: can your **eye** see the power law? that it is inverse cubic?

Returns **non-Gaussian** (known **qualitatively**, but under-appreciated!)

Large events cluster (like earthquakes) (also known **qualitatively**)

“Aftershocks” Omori-correlated (Palermo 03; BU 07)

“Aftershocks of each aftershock” also Omori correlated: (BU)

**Bachelier 1900 Market “model” :
UN-CORRELATED DRUNK**

$$(x^2)_t = t/2.$$

FOR d=2 DIMENSIONS:

$$(y^2)_t = t/2.$$

$$(|r|^2)_t = (x^2)_t + (y^2)_t = t.$$

**INVENTED IN ANAGNI
ITALY (1104 Church
Floor)**

**BUT
discovered in 1984
by a 5-year old girl**



Tile your Kitchen floor economically....saving tiles



(a)

$$\begin{aligned} L &= 2^0 \\ M &= 3^0 \\ \rho &= \left(\frac{3}{4}\right)^0 \end{aligned}$$



(b)

$$\begin{aligned} L &= 2^1 \\ M &= 3^1 \\ \rho &= \left(\frac{3}{4}\right)^1 \end{aligned}$$

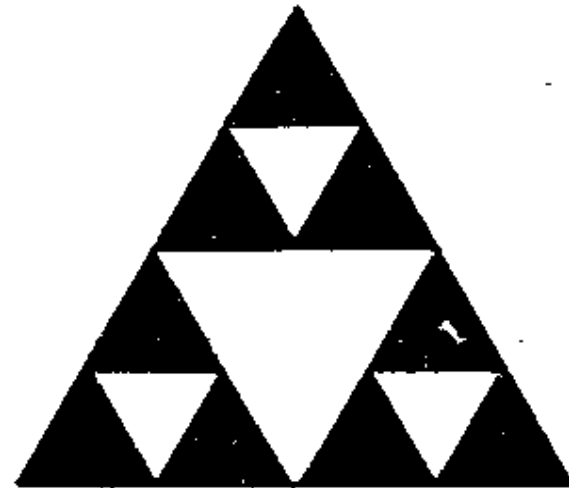

(c)

$$\begin{aligned} L &= 2^2 \\ M &= 3^2 \\ \rho &= \left(\frac{3}{4}\right)^2 \end{aligned}$$

...

...

Q: How to QUANTIFY???

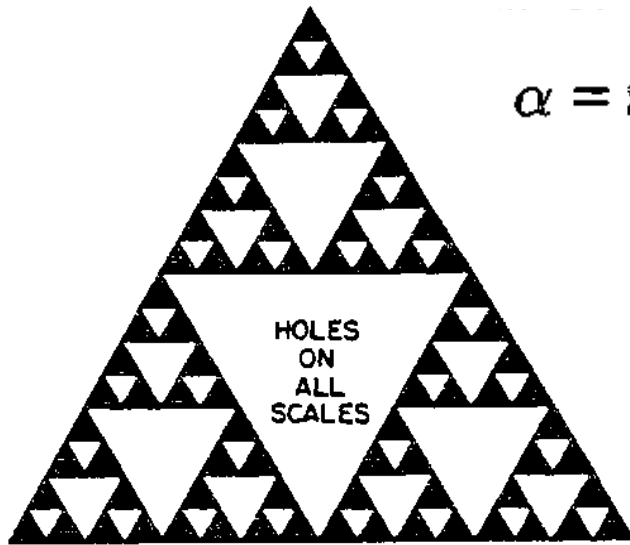

$$\alpha = \text{slope} = \frac{\log 1 - \log(3/4)}{\log 1 - \log 2} = \frac{\log 3}{\log 2} - 2.$$

$$M(L) \equiv A L^{d_f}.$$

$$\rho(L) = A L^{d_f - 2}.$$

$$d_f = \log 3 / \log 2 = 1.58 \dots$$

d=3: You remove a **BABY** tetrahedron from middle of the Great Pyramid

$$d_f = \log(d + 1) / \log 2.$$

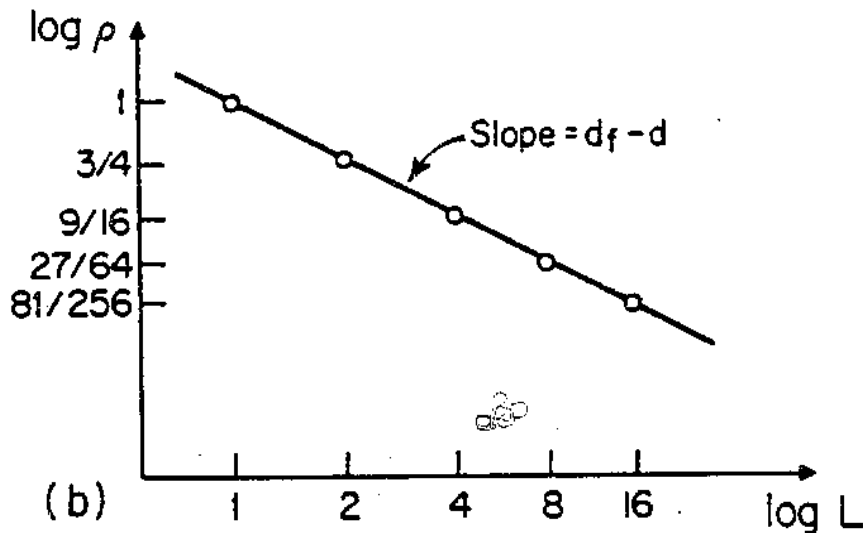

Measuring the length of a coastline

$$\text{Length} = N(L) * L$$

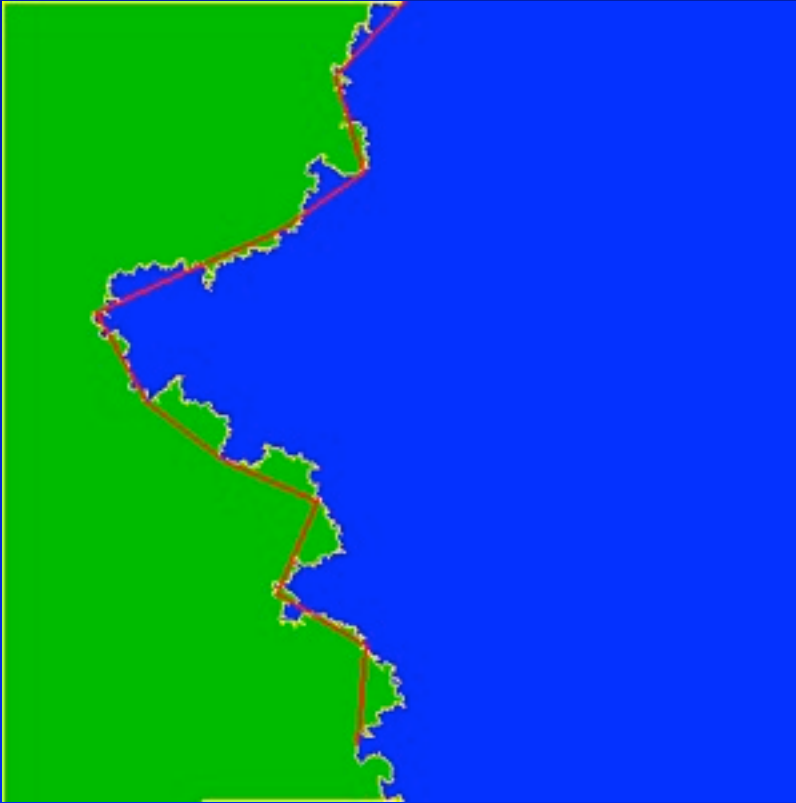

$$N(50) = 12$$

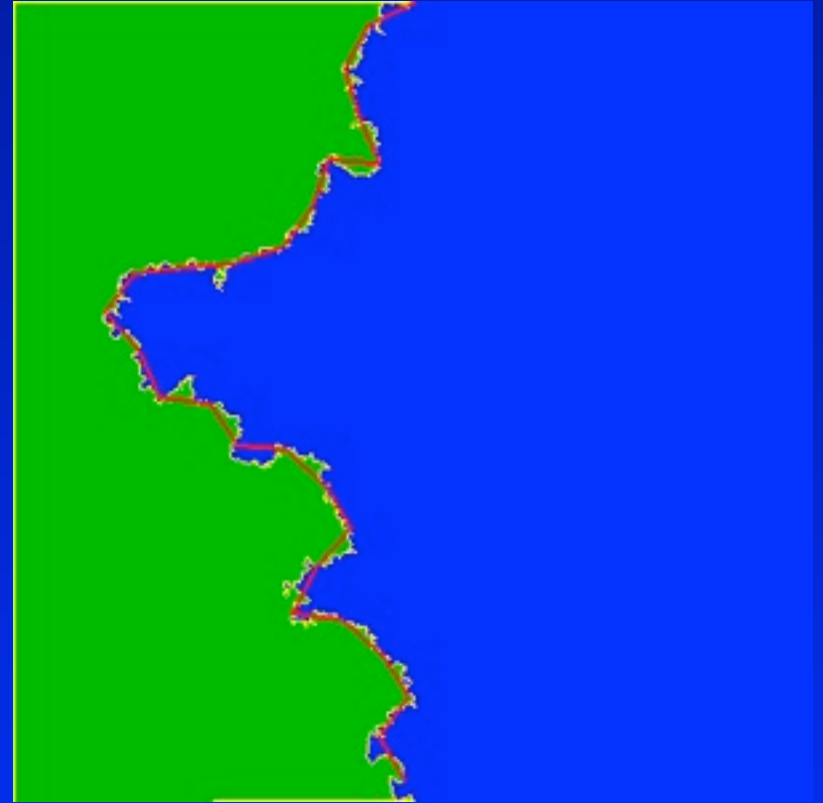

$$N(25) = 26$$

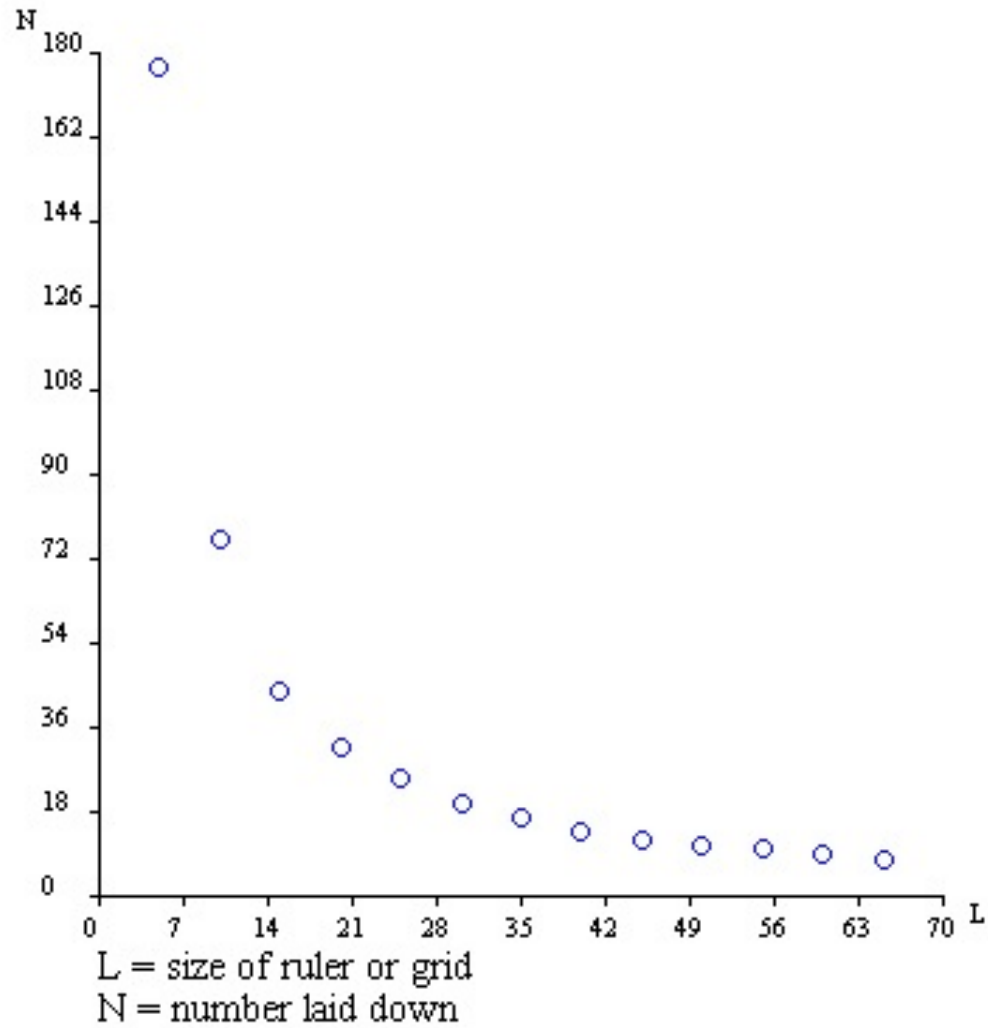

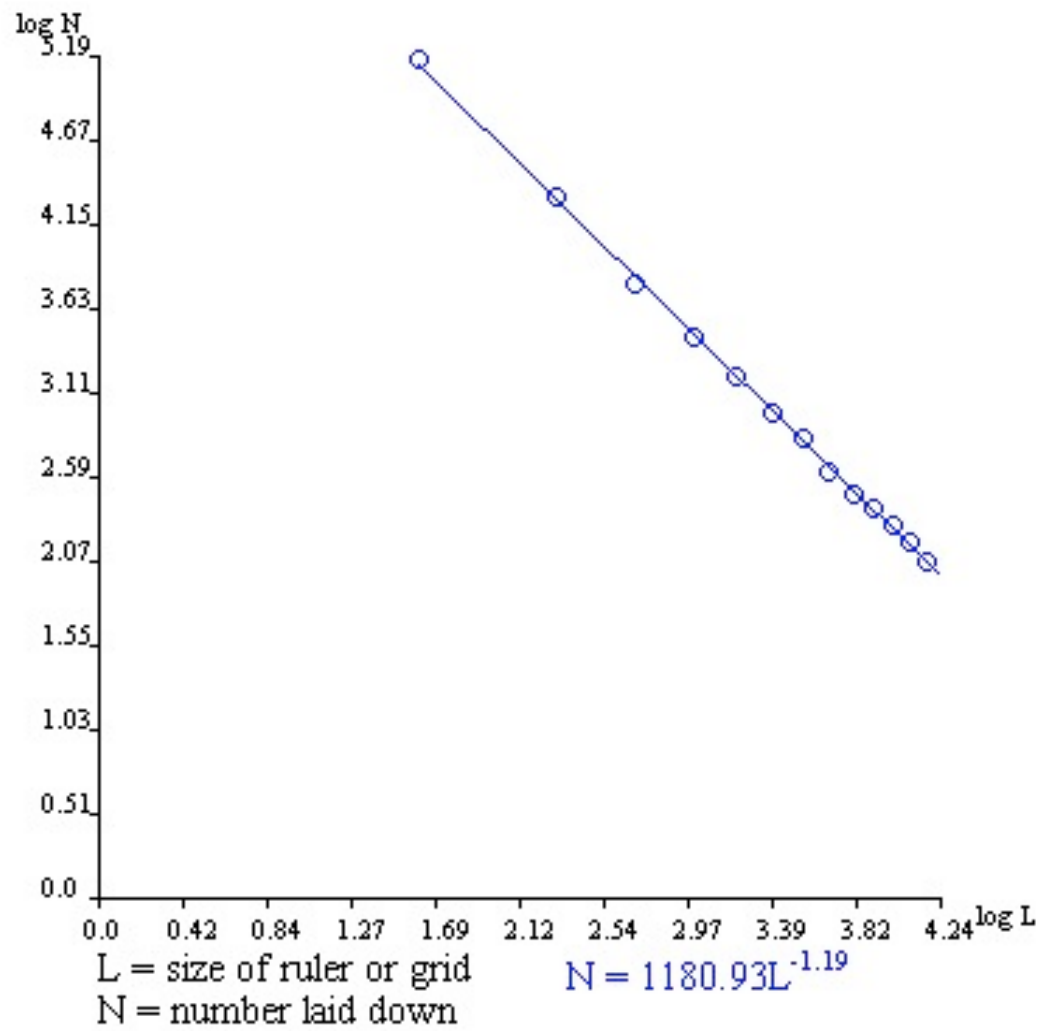

Fractals Everywhere

- Spatial structure: tree, lung, coral, etc
- Symbolic sequence: DNA, computer code, etc
- Temporal dynamics: weather temperature, music, **volatility of stock price**, etc
- Feature: lack of characteristic spatial and temporal scale

Random Walk

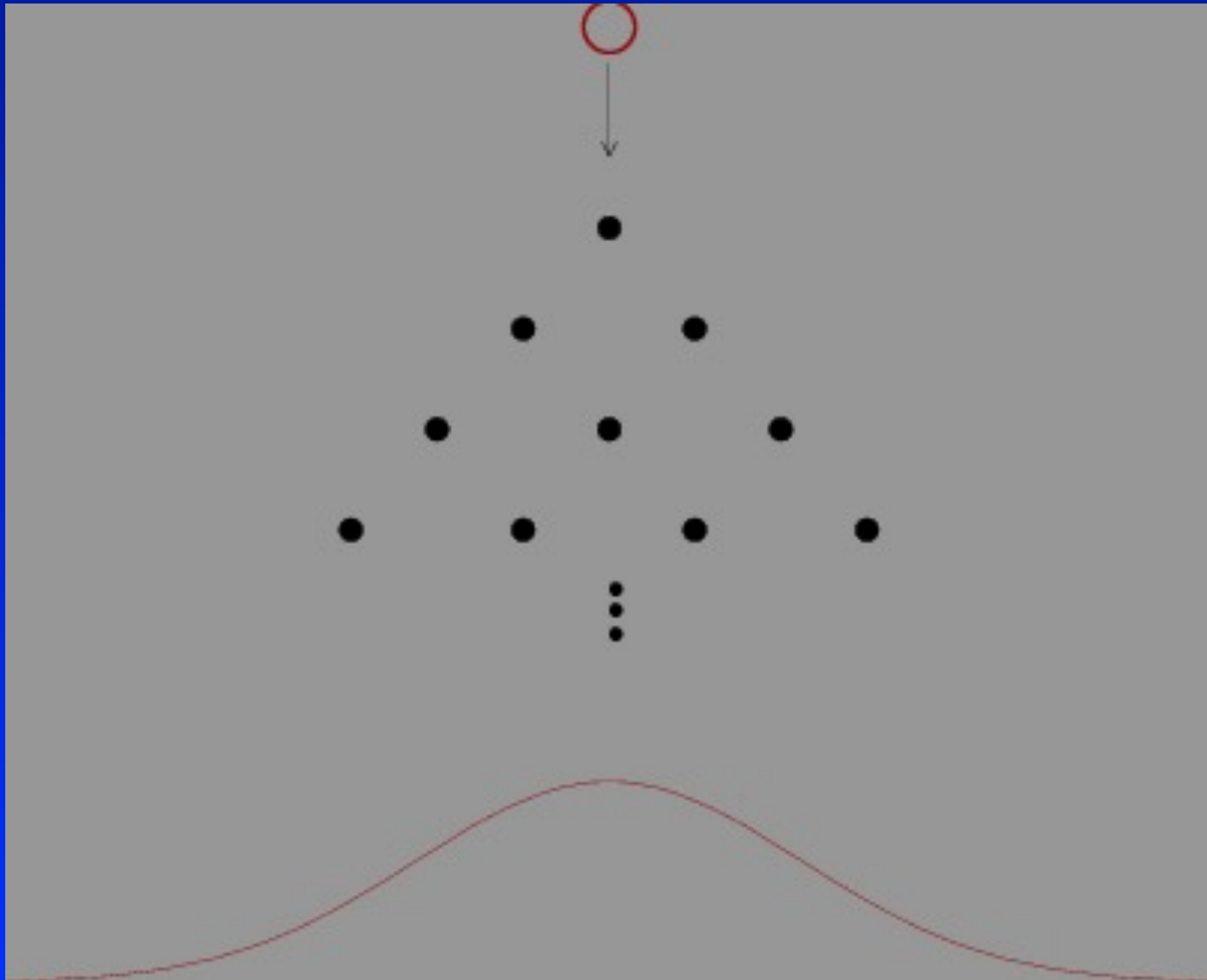

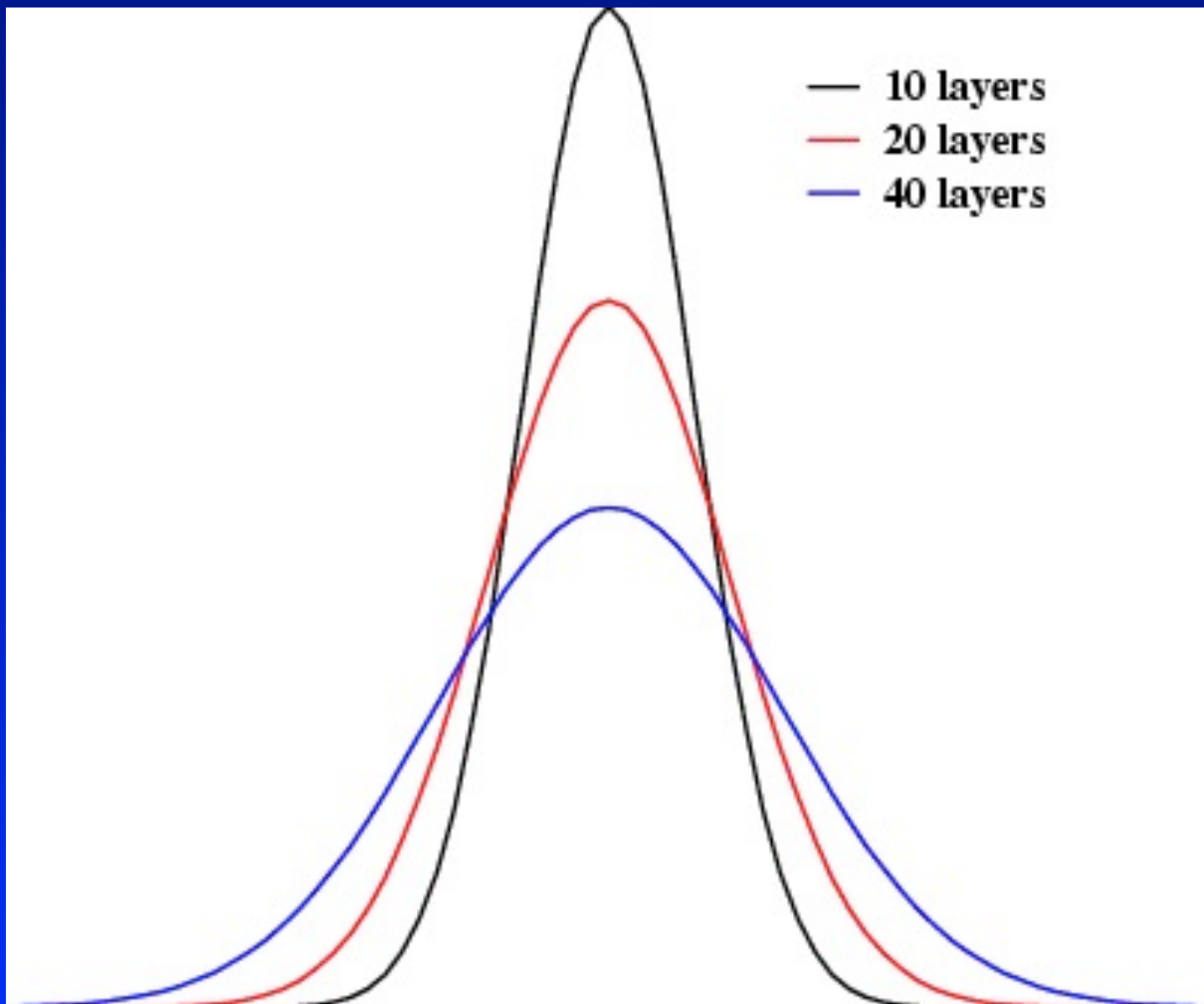

The characteristic scale describing the distribution is its “width”

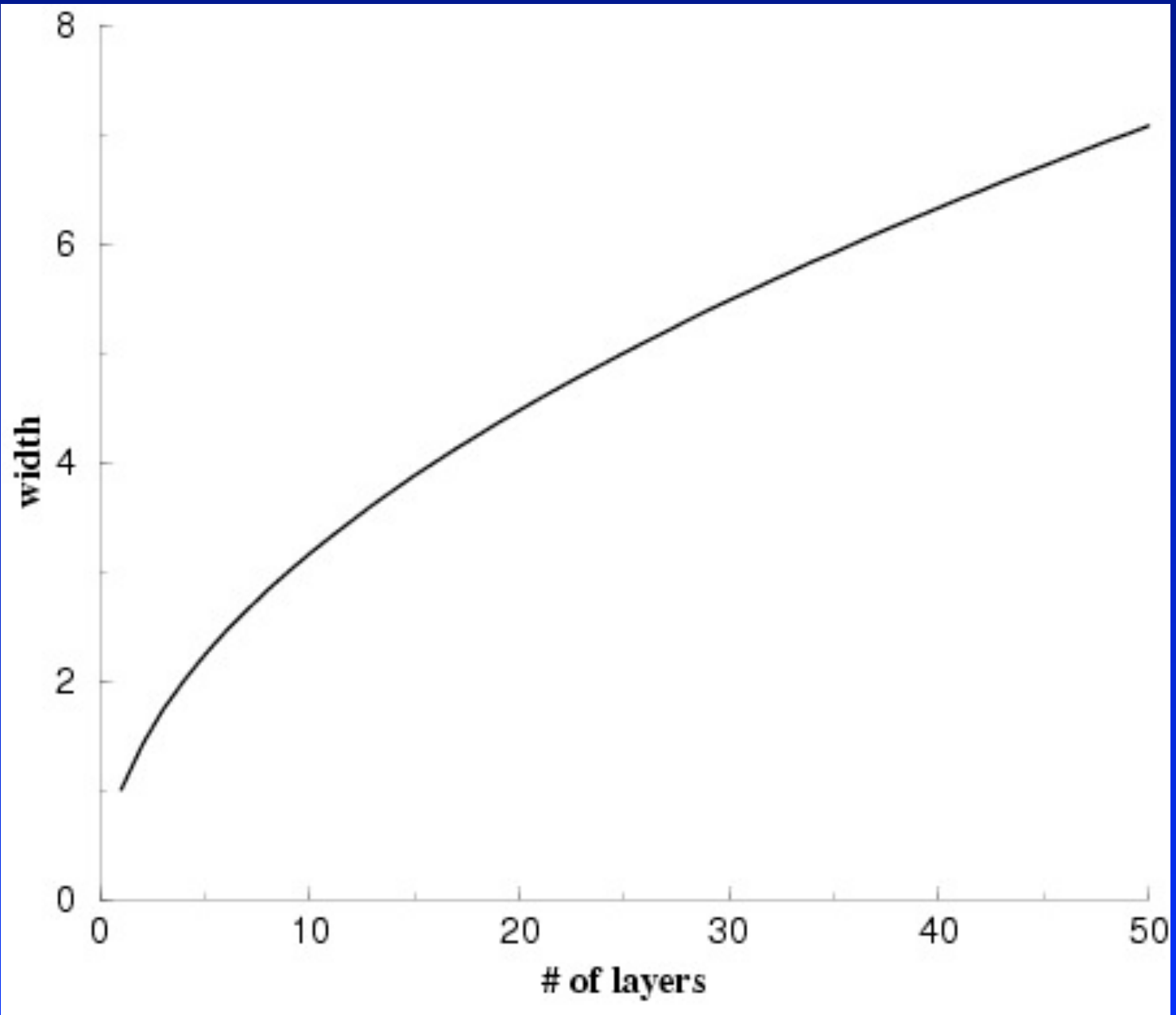

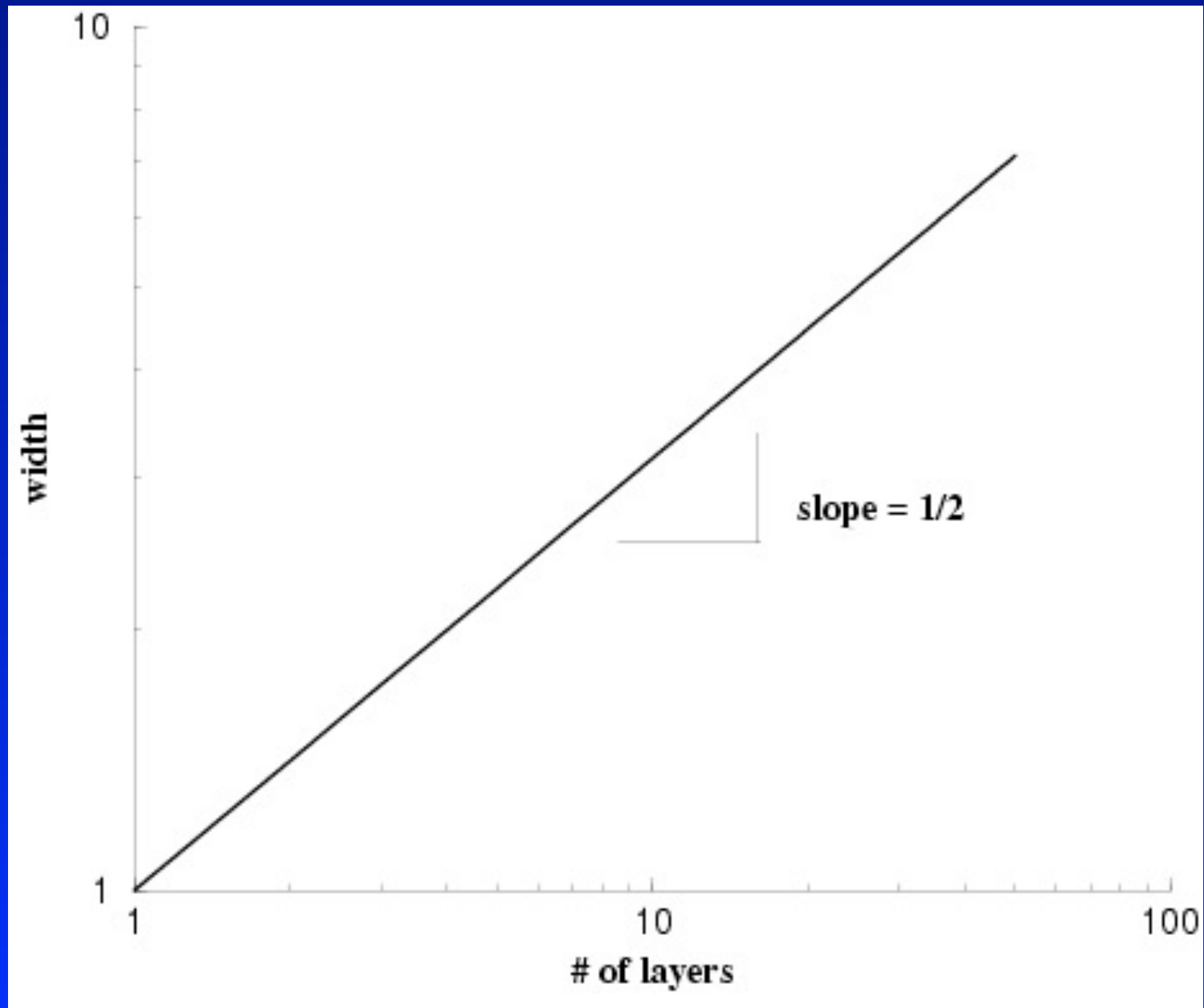

Self-Similarity of a Time Series

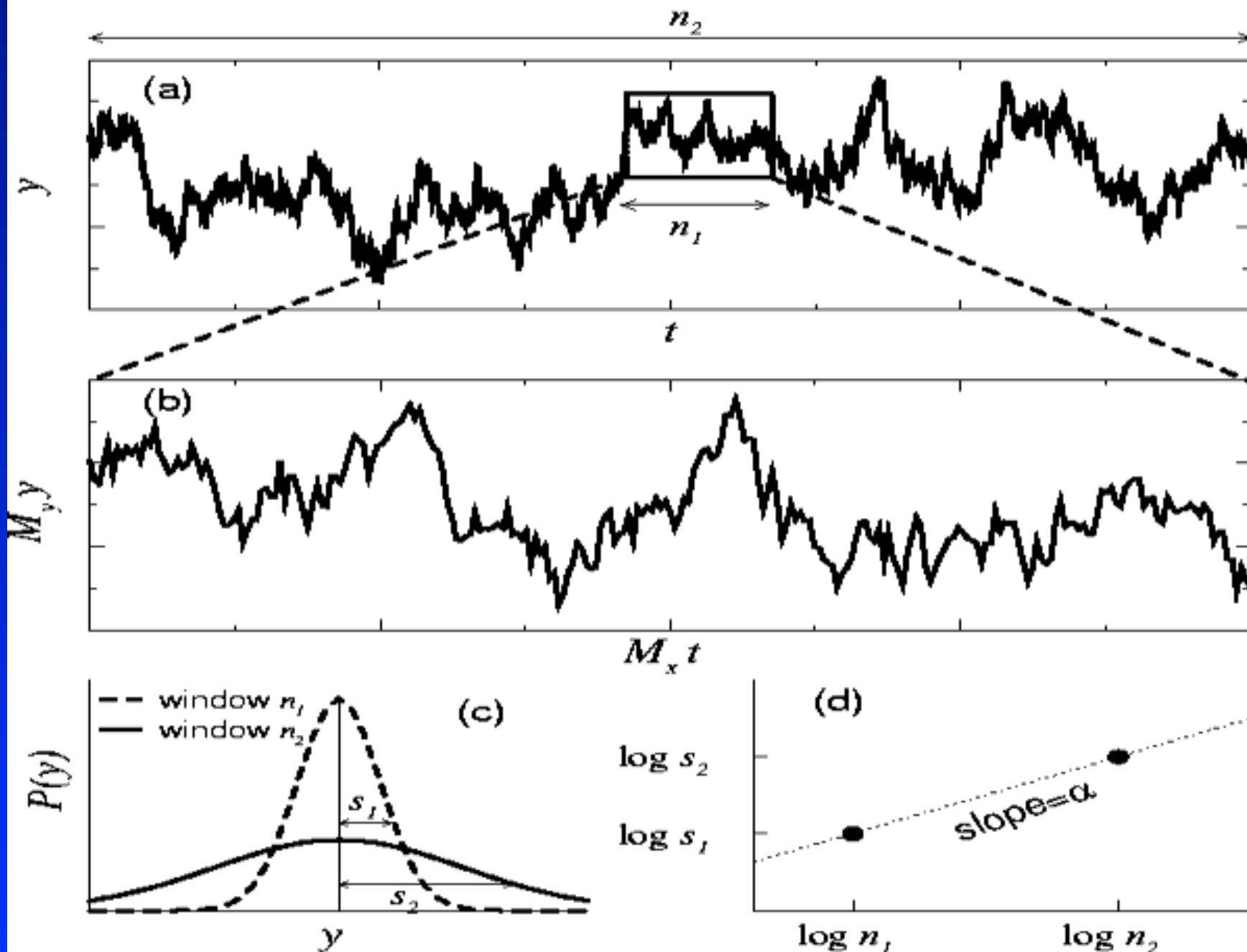

Detrended Fluctuation Analysis (DFA)

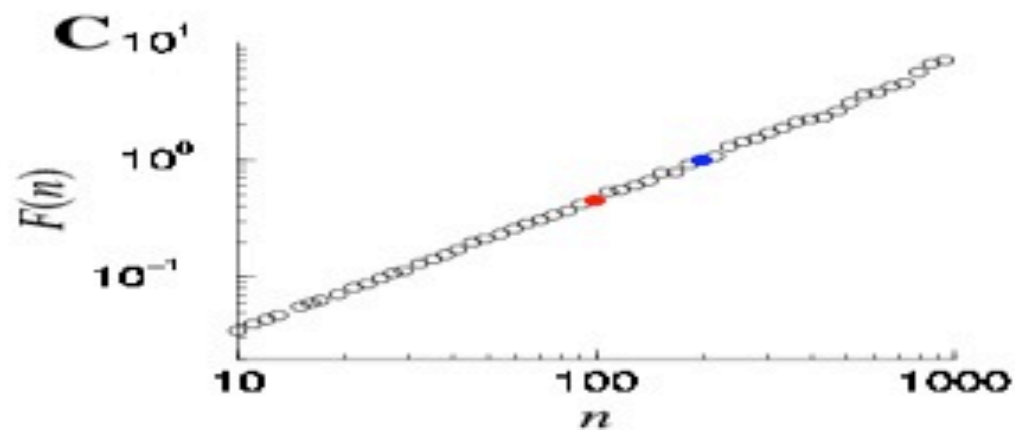
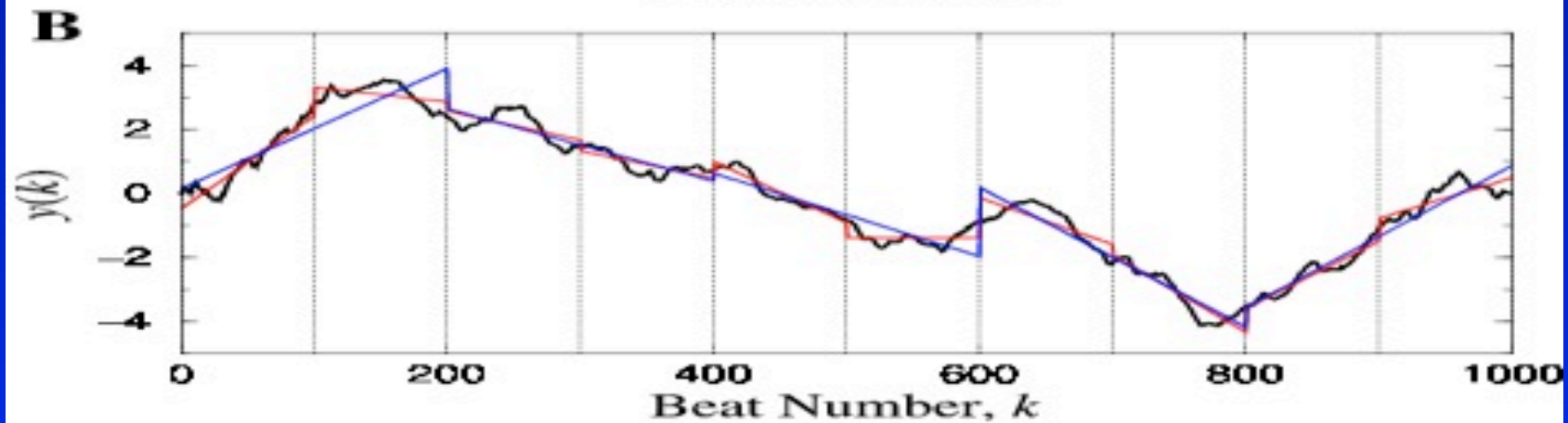
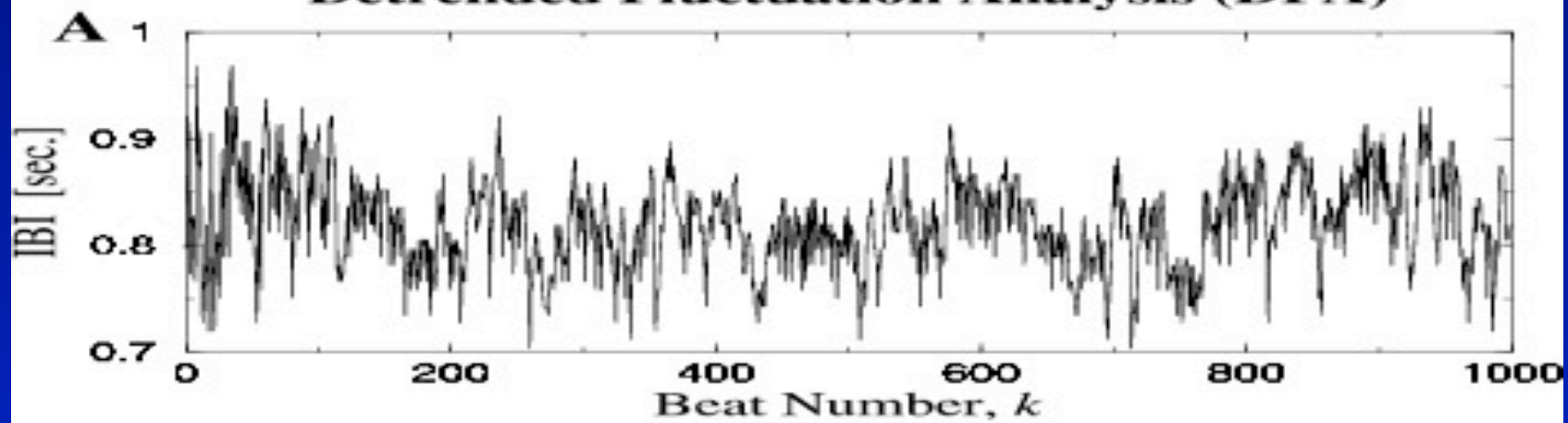

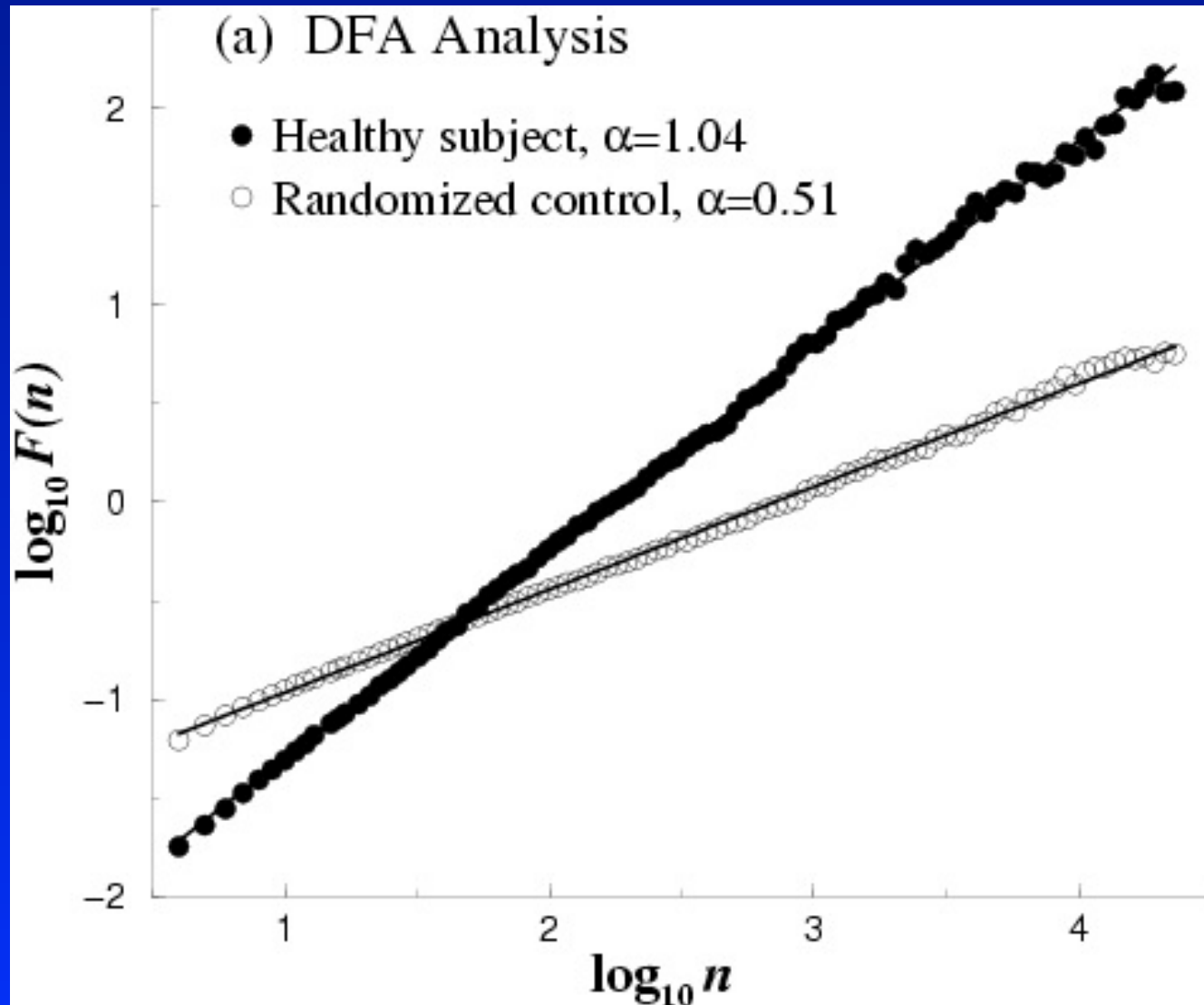

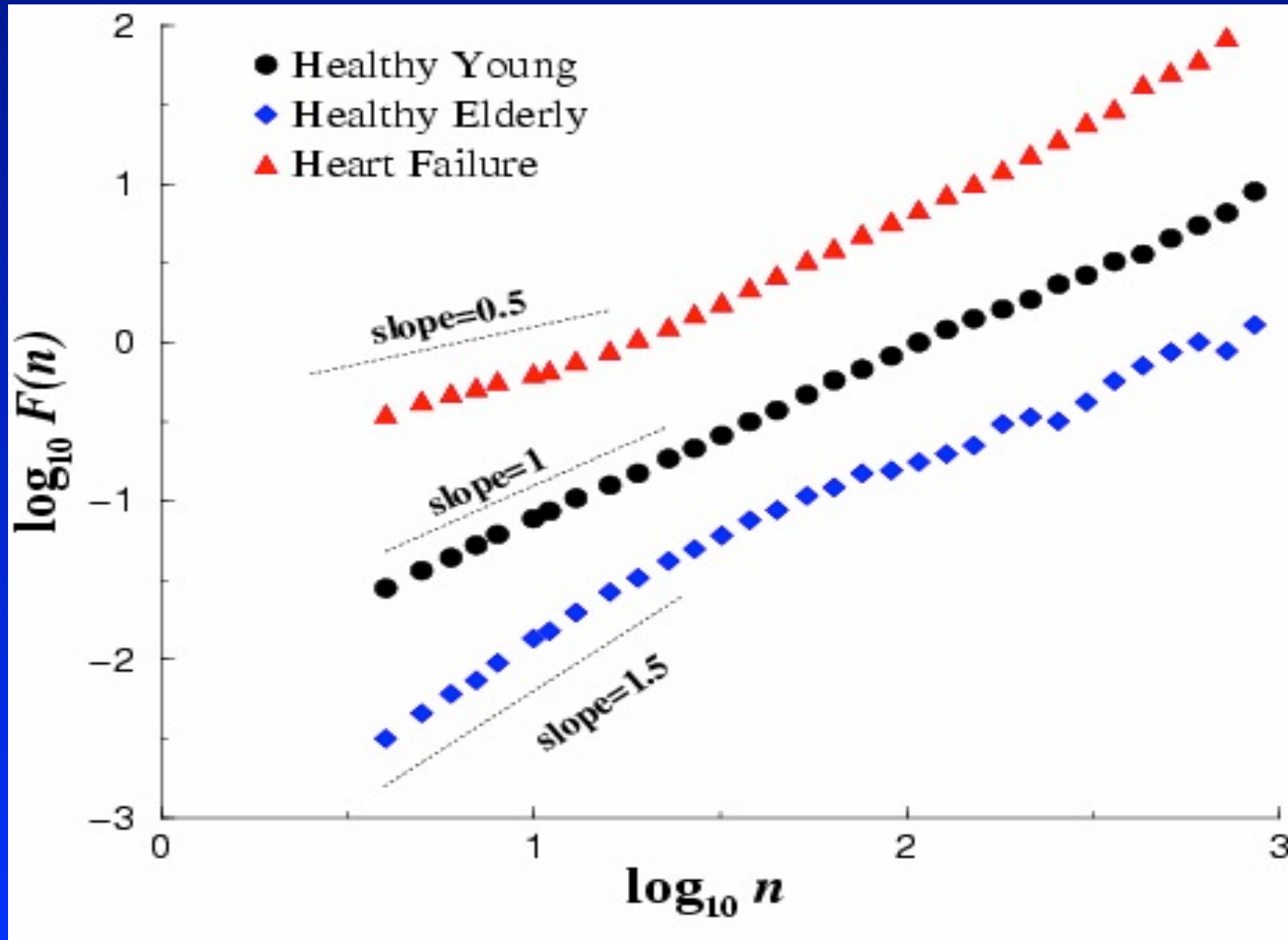

Higher Dimensions

$$\langle A \rangle \equiv \sum_c A_c P_c,$$

dimension $d=1$

dimension $d=2$

$$\langle x \rangle_t = \sum_c x_c P_c = 0.$$

$$\langle \mathbf{r} \rangle_t = 0$$

$$\langle x^2 \rangle_t = t.$$

$$\langle |\mathbf{r}|^2 \rangle_t = t.$$

$$\langle x^4 \rangle_t = 3t^2 - 2t = 3t^2 \left[1 - \frac{2/3}{t} \right]$$

$$\langle |\mathbf{r}|^4 \rangle_t = 2t^2 \left[1 - \frac{1/2}{t} \right]$$

phenomena is that the *exponents* are quite robust but *amplitudes depend more sensitively* on what particular system is being studied.

Linear polymers are topologically linear chains of monomers held together by chemical bonds (like a string of beads). Let us make an oversimplified model of such a linear polymer by assuming that the chain of monomers adopts a conformation in three-dimensional space that has the same statistics as the *trail* of the ant. By the trail we mean the object formed if the ant leaves behind a little piece of bread at each site visited. After a time t , the ant has left behind t pieces of bread; hence the analog of the time is the number of monomers in the polymer chain. An unrealistic feature of this simple model arises whenever the ant re-visits the same site. Then more than one piece of bread occupies the same site, while two monomers *cannot* occupy the same point of space. In Sect. 5.8, we shall see that statistical properties of a random walk provide a useful upper bound on the properties of real polymers, and that this upper bound becomes the exact value of d_f for space dimensions above a critical dimension d_c .

$$R_g = \frac{1}{\sqrt{6}} R_{EE}$$

Thus we find identical scaling properties no matter what definition we choose – the moment \mathcal{L}_k of (5.13), the radius of gyration R_g of the trail, or the end-to-end displacement of the entire walk. In this sense, there is only ‘one characteristic length’. When such a characteristic length is referred to, generically, it is customary to use the symbol ξ .

Functional Equations and Scaling: One Variable

We have seen that several different definitions of the characteristic length ξ all scale as \sqrt{t} . Equivalently, if $t(\xi)$ is the characteristic time for the ant to 'trace out' a domain of linear dimension ξ , then

$$t \sim \xi^2. \tag{5.18}$$

More formally, for all positive values of the parameter λ such that the product $\lambda\xi$ is large, $t(\xi)$ is, asymptotically, a *homogeneous function*,

$$t(\lambda^{1/2}\xi) = \lambda t(\xi). \tag{5.19}$$

THE SOLUTION OF THE FUNCTIONAL EQUATION (5.19) IS A POWER LAW.....CONVERSELY THE POWER LAW (5.18) OBEYS THE FUNCTIONAL EQUATION (5.19)

THE CONNECTION BETWEEN A POWER LAW AND A FUNCTIONAL EQUATION IS CALLED **SCALING SYMMETRY**... A VERY BASIC SYMMETRY IN MANY BRANCHES OF PHYSICS & ECONOMICS.

Fractal dimension of the unbiased random walk

$$t(\lambda\xi) = \lambda^{d_f} t(\xi), \quad (5.20b)$$

then we see that d_f plays the role of a scaling exponent governing the *rate* at which we must scale the time if we wish to trace out a walk of greater spatial extent. For example, if we wish a walk whose trail has twice the size, we must wait a time 2^{d_f} . Similarly, if we wish to ‘design’ a polymer with twice the radius of gyration, we must increase the molecular weight by the factor 2^{d_f} .

It is significant that the fractal dimension d_f of a random walk is 2, *regardless of the dimension of space*. This means that a time exposure of a ‘drunken firefly’ in three-dimensional space is an object with a well-defined dimension,

$$d_f = 2. \quad (5.21)$$

Similarly, a time exposure in a Euclidean space of any dimension d produces an object with the identical value of the fractal dimension, $d_f = 2$.

Let us place our ant again on a one-dimensional lattice, but now imagine that its coin is *biased*. The probability to be heads is

$$p \equiv \frac{1 + \varepsilon}{2}, \quad (5.22)$$

while the probability to be tails is $q \equiv 1 - p = (1 - \varepsilon)/2$. From (5.22) we see that the parameter

$$\varepsilon = 2p - 1 = p - q. \quad (5.23)$$

defined in (5.22) is the difference in probabilities of heads and tails; ε is called the *bias*. We say that such an ant executes a *biased random walk*.

Now the expectation value $\langle x \rangle_t$ is not zero, as it was for the unbiased ant. we find that (5.8) is replaced by

$$\langle x \rangle_t = (p - q)t = \varepsilon t.$$

Thus the bias ε plays the role of the *drift velocity* of the center of mass of the probability cloud of the ant, since the time derivative of $\langle x \rangle_t$ is the analog of a velocity.

$$\langle x^2 \rangle_t = [(p - q)t]^2 + 4pqt = \varepsilon^2 t^2 + (1 - \varepsilon^2)t. \quad (5.26)$$

If $\varepsilon \equiv p - q = 0$, the results (5.25) and (5.26) reduce to (5.8) and (5.9). We thus recover the unbiased ant, for which the characteristic length ξ scales as \sqrt{t} . For any non-zero value of ε , no matter how small, we see from (5.25) and (5.26) that asymptotically

$$\mathcal{L}_k \equiv \sqrt[k]{\langle x^k \rangle} \sim t. \quad (5.27)$$

for $k = 1, 2$ respectively (the general- k result is a bit of an exercise!). Thus we conclude that the ξ scales linearly in time: the fractal dimension of the walk changes *discontinuously* with ε from $d_f = 1$ for all non-zero ε to $d_f = 2$ for $\varepsilon = 0$

BIG BIG PARADOX: CONTINUOUS OR DISCONTINUOUS?????

Here is a paradox! The dependence of d_f on bias ε is a *discontinuous* function of ε , yet the actual motion of the ant cannot differ much as ε changes infinitesimally. To resolve this paradox, consider a specific example of a biased walk with an extremely small value of bias, say $\varepsilon_0 = 10^{-6}$. The r.h.s. of (5.26) has two terms. If only the first term were present, the ant would simply 'drift' to the right with uniform velocity ε . If only the second term were present, the motion of the biased ant would be the same as that of the unbiased ant, except that the width of the probability distribution would be reduced by a factor $(1 - \varepsilon^2)$. To see which term dominates, we express the r.h.s. as $[\varepsilon^2 t + 1]t$. We can now define an important concept, the *crossover time* $t_\times = 1/\varepsilon^2$. For $t \ll t_\times$ the second term dominates and the ant has the statistics of an *unbiased* random walk; we say that the trail has an *apparent* fractal dimension $d_f = 2$. For $t \gg t_\times$, the first term dominates and the ant has the statistics of a *biased* random walk; the trail assumes its *true* or asymptotic fractal dimension $d_f = 1$ (Fig. 5.3b). Note that the crossover time t_\times is quite large if the bias is small. If the bias is, say, 0.001, then the ant must walk a million steps before its trail becomes distinguishable from that of an unbiased ant!

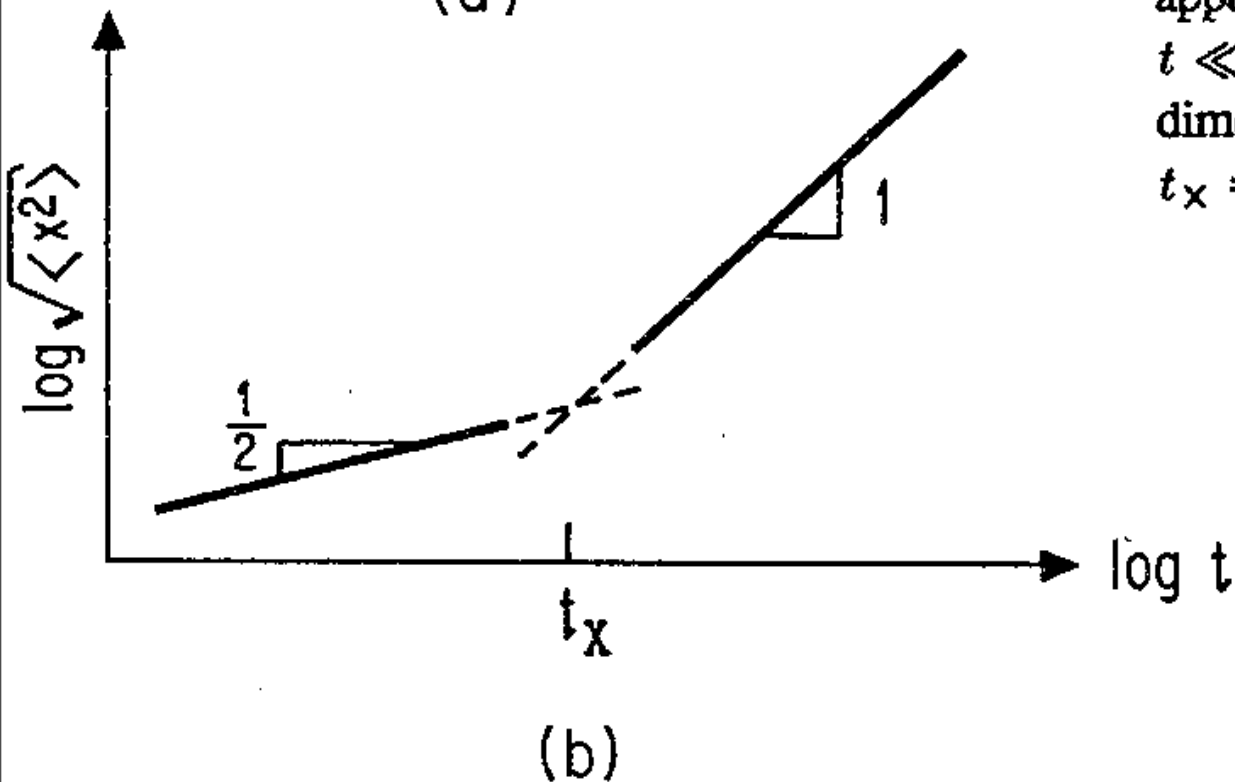
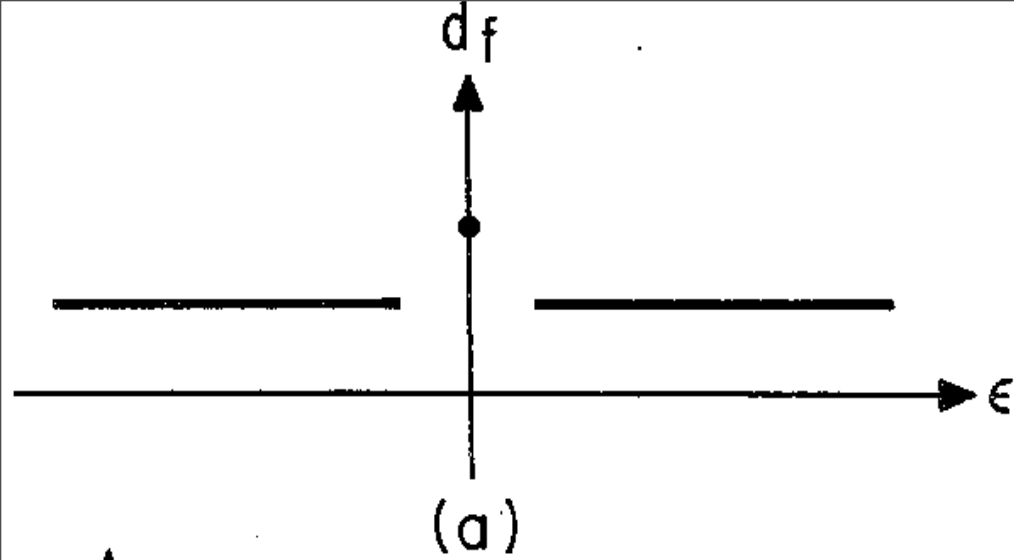

Fig. 5.3. (a) The *discontinuous* change in fractal dimension d_f for the biased random walk as the active parameter $\varepsilon \equiv p - q$ is varied. (b) The *continuous* change in $\langle x^2 \rangle$ as a function of time for a small value of the bias parameter $\varepsilon = p - q = 10^{-3}$. Note the crossover between the apparent fractal dimension $d_f = 2$ for $t \ll t_x$ to the asymptotic fractal dimension $d_f = 1$ for $t \gg t_x$, where $t_x = 1/\varepsilon^2$ is the crossover time.

Application: Quasi-2-dimensional magnets ²⁶

Functional Equations & Scaling for > 1 variables

to two independent variables. We say a function $f(u, v)$ is a *generalized homogeneous function* if there exist two numbers a and b (termed scaling powers) such that for all positive values of the parameter λ , $f(u, v)$ obeys the obvious generalization of (5.19),

$$f(\lambda^a u, \lambda^b v) = \lambda f(u, v). \quad (5.28)$$

We can see by inspection of (4.46c) that the free energy near the critical point obeys a functional equation of the form of (5.28), so generalized homogeneous functions must be important! To get a geometric feeling for such functions and their properties, consider the simple Bernoulli probability $\Pi(x, t)$ – the conditional probability that an ant is found at position x at time t given that the ant started at $x = 0$ at $t = 0$. In the *asymptotic* limit of large t , $\Pi(x, t)$ is expressible in closed form (unlike the free energy near the critical point!). The result is the familiar Gaussian probability density

$$\Pi_G(x, t) \equiv \frac{1}{\sqrt{2\pi t}} \exp\left[-\frac{x^2}{2t}\right], \quad (5.29)$$

Note that $\Pi_G(x, t)$ clearly satisfies (5.28), with scaling powers $a = -1$ and $b = -2$,

$$\Pi_G(\lambda^{-1} x, \lambda^{-2} t) = \lambda \Pi_G(x, t). \quad (5.30)$$

“DATA COLLAPSE” FROM 2d TO 1d

The predictions of the scaling relations (5.30) are given by the properties of generalized homogeneous functions. Among the most profound and useful of these properties is that of *data collapsing*. If (5.30) holds for all positive λ , then it must hold for the particular choice $\lambda = t^{1/2}$. With this choice, (5.30) becomes

$$\frac{\Pi_G(x, t)}{t^{-1/2}} = \Pi_G\left(\frac{x}{t^{1/2}}, 1\right) = \mathcal{F}(\tilde{x}), \quad (5.31a)$$

where we have defined the *scaled variable* \tilde{x} by

$$\tilde{x} \equiv \frac{x}{t^{1/2}}. \quad (5.31b)$$

Equation (5.31a) states that if we ‘scale’ the probability distribution by dividing it by a power of t , then it becomes a function of a *single* scaled distance variable obtained by dividing x by a different power of t . Instead of data for $\Pi(x, t)$ falling on a family of curves, one for each value of t , data *collapse* onto a single curve given by the *scaling function* $\mathcal{F}(\tilde{x})$ (Fig. 5.4). This reduction from

a function of n variables to a function of $n - 1$ *scaled* variables is a hallmark of fractals and scaling. The ‘surprise’ is that the function $\mathcal{F}(\tilde{x})$ defined in (5.31a) at first sight would seem to be a function of *two* variables, but it is in fact a function of only a single scaled variable \tilde{x} .

“DATA COLLAPSE” FROM 2d TO 1d

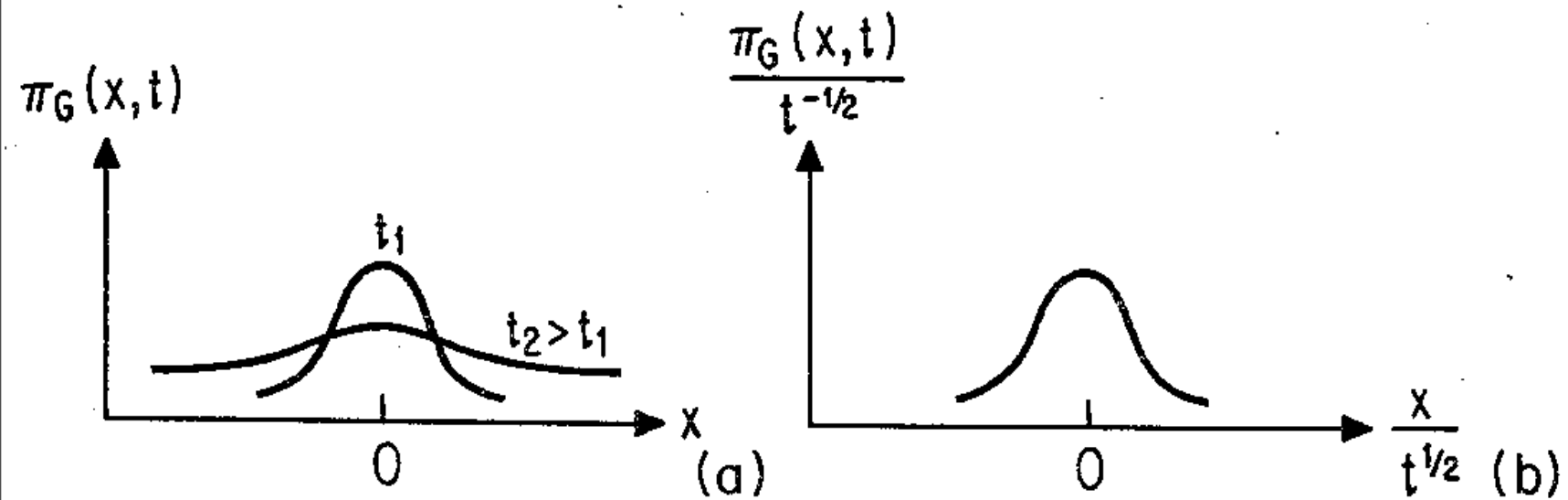

Fig. 5.4. Schematic illustration of scaling and data collapse as predicted by (5.31) for $\Pi_G(x, t)$, the Gaussian probability density.

A remarkable fact is that in sufficiently high spatial dimensions the SAW has the *identical* fractal dimension as the unbiased random walk, because in sufficiently high dimension the probability of intersection is so low as to be negligible. To see this, we first note that the *co-dimension* $d - d_f$ of the fractal trail is an exponent governing how the fraction of space 'carved out' by the trail decreases with length scale L , since from (5.1) ρ decreases as $\rho(L) \sim M(L)/L^d \sim (1/L)^{d-d_f}$. Now if two fractal sets with dimensions d'_f and d''_f intersect in a set of dimension d_\cap , then the *sum* of the co-dimensions of the two sets is equal to the co-dimension of the intersection set,

$$d - d_\cap = (d - d'_f) + (d - d''_f). \quad (5.32)$$

This general result follows from the fact that a site belongs to the intersection only if it belongs to both fractals: since statistically independent probabilities multiply (p. 116), the fraction of space (with exponent $d - d_\cap$) carved out by *both* fractals is the product of the fractions of space (with exponents $d - d'_f$ and $d - d''_f$) carved out by each.

To apply (5.32) to the trail of a random walk, consider the trail as being two semi-infinite trails – say red and blue – each with random walk statistics. If we substitute $d'_f = d''_f = 2$ in (5.32), we find that for d equal to a critical dimension $d_c = 4$ the red and blue chains will intersect in a set of zero dimension. Thus for $d > d_c$, the 'classical' random walk suffices to describe the statistical properties of self-avoiding polymers!

Take Home Message: The Self-Avoiding Constraint irrelevant above $d=4$

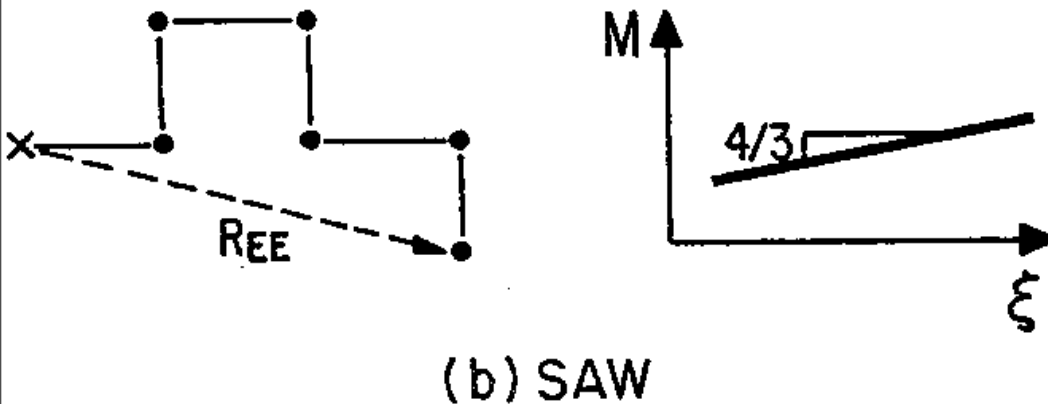
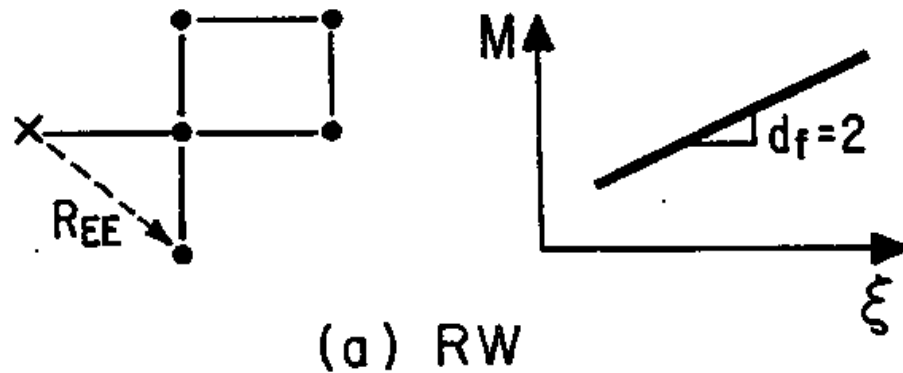

Fig. 5.5a–b. Schematic illustration of (a) a random walk, and (b) a self-avoiding walk (SAW). Each has taken 6 steps. We show just one of the 4^6 possible 6-step walks – many of these have zero weight for the SAW case. Shown also are schematic log-log plots showing how many steps are needed (the ‘mass’ M of the trail) for the walk to explore a region of characteristic size ξ , where here ξ is identified with the mean end-to-end distance R_{EE} .